



High Efficiency, Synchronous 5A Buck Charger for 1 cell Li-ion Battery with NVDC Power Path Management

1 DESCRIPTION

The SC89890H is a 1.5MHz highly integrated switch-mode buck charger for 1 cell Li-ion battery applications and NVDC system power path management, which separate the system load and charge current, also the system can power up with deep depletion battery. System can get the power from VBUS, VBAT or both. It supports 3.9-13.5V input voltage, up to 5A charging current and provide battery charge management functions including trickle charge, constant current charge, constant voltage charge, charge termination, auto recharge and charging status indication.

The SC89890H supports flexible charge current option, and the user can program the current freely through external resistor for different applications. With the charger management function, the IC can be used to charge 1 cell Li-ion battery.

The SC89890H supports USB OTG with up to 2.4A output with PFM/PWM mode. Meanwhile, the SC89890H supports USB Input and High Voltage fast charge Adapters, auto detect USB BC1.2, SDP, CDP, DCP.

The SC89890H supports input current and voltage limit, input under voltage and over voltage protections, internal cycle by cycle current limit, battery short circuit protection, and output over voltage protection. It also offers charging safety timer and over temperature protection to ensure safety under different abnormal conditions.

The SC89890H integrated all MOSFETs, current sensing , loop compensation and I2C interface.

The SC89890H is available in QFN(24)-4*4 package.

2 FEATURES

- Integrated Synchronous Buck Charger
- Integrated NVDC Power Path Management
- Charging Management (Trickle Charge / Constant Current Charge / Constant Voltage Charge / Charge Termination)
- Integrated I2C interface
- I2C Programmable Constant Charge Current, $\pm 5\%$ @1.5A-5A accuracy
- I2C Programmable Constant Voltage, $\pm 0.5\%$ accuracy
- I2C Programmable Charge Safety Timer
- Support OTG discharging function and I2C Programmable Output Voltage: 3.9V~5.4V with up 2.4A current
- Support Shipping mode, Low battery leakage current
- Charge Status Indication
- Integrated ADC for System Monitor
- Resistance Compensation (IRCOMP) from Charger Output to Cell Terminal and ICO Support
- NTC for Battery Protection (support JEITA standard)
- Input Under Voltage and Over Voltage Protection
- Internal Cycle by Cycle Over Current Protection
- OTG OCP/OVP Protection
- Battery Over Voltage and Short Protection
- Battery Discharging Over Current and under voltage Protection
- Thermal Regulation and Shutdown
- QFN (24)-4*4 footprint

3 APPLICATIONS

- Smart Phones
- Portable Internet Devices and Accessory

4 DEVICE INFORMATION

Part Number	Package	Dimension
SC89890HQDLR	QFN(24)-4*4	4x4



5 Typical Application Circuit

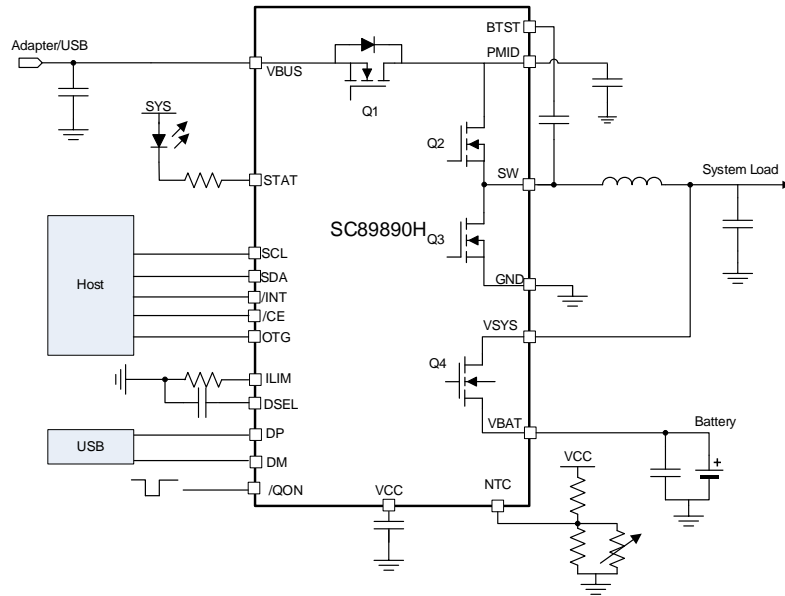



6 Terminal Configurations and Functions

QFN(24) 4x4 (TOP View, SC89890H)

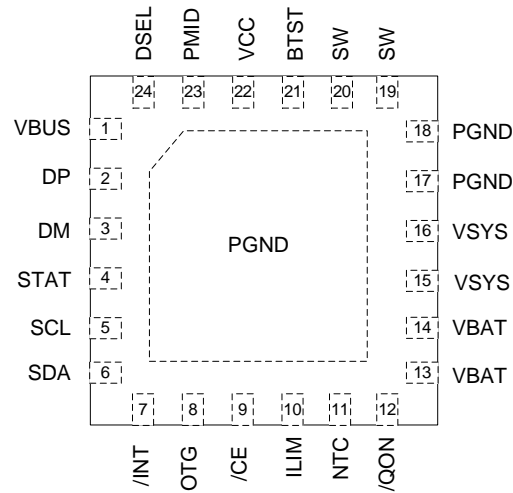

I/O			DESCRIPTION
SC89890H	NAME		
1	VBUS	I	Power supply pin. Place a 1uF ceramic capacitor from VBUS to GND close to the IC
2	DP	IO	Positive line of the USB data line pair. DP/DM based USB host/charging port detection. The detection includes data contact detection (DCD), primary and secondary detection in BC1.2, and Adjustable high voltage adapter. The pin can be configured as output driver by DP_DAC register bits after USB Detection finished or during OTG mode.
3	DM	IO	Negative line of the USB data line pair. DP/DM based USB host/charging port detection. The detection includes data contact detection (DCD), primary and secondary detection in BC1.2, and Adjustable high voltage adapter. The pin can be configured as output driver by DM_DAC register bits after USB Detection finished or during OTG mode.
4	STAT	O	Open-drain charge status output. Connect the STAT pin to a logic rail via 10-kΩ resistor. The STAT pin indicates charger status. Collect a current limit resistor and a LED from a rail to this pin. Charge in progress: LOW Charge complete , charger in SLEEP mode and charger disable: HIGH Charge suspend (fault response): 1-Hz, 50% duty cycle Pulses .
5	SCL	I	I2C interface clock. Connect SCL to the logic rail through a 10-kΩ resistor.
6	SDA	IO	I2C interface data. Connect SDA to the logic rail through a 10-kΩ resistor.
7	/INT	O	Open-drain interrupt Output. Connect the INT to a logic rail through 10-kΩ resistor. The INT pin sends an active low, 256-μs pulse to host to report charger device status and fault.
8	OTG	I	Active high enable pin during boost mode. The boost mode is activated when OTG_CONFIG =1 and OTG pin is high
9	/CE	I	Active low Charge Enable pin. Battery charging is enabled when CHG_CONFIG = 1 and /CE pin = Low. /CE pin must be pulled High or Low.
10	ILIM	I	Input current limit Input. ILIM pin sets the maximum input current and can be used to monitor input current . ILIM pin sets the maximum input current limit by regulating the ILIM voltage at 0.8 V. A resistor is connected from ILIM pin to ground to set the maximum limit as $I_{INMAX} = K_{ILIM}/R_{ILIM}$. The actual input current limit is the lower limit set by ILIM pin (when



			EN_ILIM bit is high) or IINLIM register bits. Input current limit of less than 500 mA is not support on ILIM pin. ILIM pin can also be used to monitor input current when the voltage is below 0.8V. The input current is proportional to the voltage on ILIM pin and can be calculated by $IIN = (KILIM \times VILIM) / (RILIM \times 0.8)$ The ILIM pin function can be disabled when EN_ILIM bit is 0.
11	NTC	IO	Connect to the Negative Temperature Coefficient (NTC) thermistor inside the battery cells to sense the battery cells temperature for protection.
12	/QON	I	BATFET enable/reset control input. When BATFET is in ship mode, a logic low of $t_{SHIPMODE}$ duration turns on BATFET to exit shipping mode. When VBUS is not plugged-in, a logic low of t_{QON_RST} (minimum 8 s) duration resets SYS (system power) by turning BATFET off for t_{BATFET_RST} (minimum 250 ms) and then re-enable BATFET to provide full system power reset. The pin contains an internal pull-up to maintain default high logic.
13,14	VBAT	O	Battery connection point to the positive terminal of the battery pack. Connect a 10uF ceramic capacitor close to the VBAT pin.
15,16	VSYS	O	Converter output connection point. Connect a 20 μ F capacitor close to the VSYS pin.
17,18	PGND	I	Power ground pin.
19,20	SW	O	Switching node output. Connected to output inductor. Connect the 47nF bootstrap capacitor from SW to BTST.
21	BTST	IO	PWM high side driver positive supply. Internally, the BTST pin is connected to the cathode of the boost-strap diode. Connect the 47nF bootstrap capacitor from SW to BTST.
22	VCC	O	HSFET and LSFET driver and internal supply output. Internally, VCC is connected to the anode of the boost-strap diode. Connect a 4.7- μ F (10-V rating) ceramic capacitor from VCC to GND. The capacitor should be placed close to the IC.
23	PMID	O	Connected to the drain of the reverse blocking MOSFET (RBFET) and the drain of HSFET. Put 10 μ F ceramic capacitor on PMID to GND.
24	DSEL	O	Active high DP/DM multiplexer selection control. Connect a 47-nF (6V rating) ceramic capacitor from DSEL to analog GND. The pin is normally low. During input source type detection, the pin drives high to indicate the device DP/DM detection is in progress and needs to take control of DP, DM signals. When detection is completed, the pin keeps high when DCP, HVDCP is detected. The pin returns to low when other input source type is detected.



7 Specification

7.1 Absolute Maximum Rating

Over operating free-air temperature range (unless otherwise noted)⁽¹⁾

		Min.	Max.	Unit
Voltage ⁽²⁾	V _{BUS}	-0.3	22	V
	P _{MID}	-0.3	22	V
	B _{TST}	-0.3	22	V
	S _W ⁽³⁾	-2(10ns)	16	V
	B _{TST} to S _W	-0.3	6	V
	D _P ,D _M ,V _{CC} ,N _{TC} ,/C _E ,V _{BAT} ,V _{SYS} ,S _{DA} ,S _{CL} ,/I _{NT} ,/Q _{ON} ,I _{LIM} , S _{TAT} ,D _{SEL}	-0.3	6	V
T _J	Operating junction temperature	-40	150	°C
T _{stg}	Storage temperature	-65	150	°C

(1) Stresses beyond those listed under absolute maximum ratings may cause permanent damage to the device.

(2) All voltages are with respect to network ground terminal.

(3) V_{BUS}, P_{MID}, B_{TST}, S_W should be tied together to test the S_W abs voltage.

7.2 Thermal Information

THERMAL RESISTANCE ⁽¹⁾		QFN (4mmX4mm)	Unit
θ _{JA}	Junction to ambient thermal resistance	34	°C/W
θ _{JC}	Junction to case resistance	25	°C/W

(1) Measured on JESD51-7, 4-layer PCB.

7.3 ESD Ratings

		Min.	Max.	Unit
V _{ESD} ⁽¹⁾	Human-body Model (HBM) ⁽²⁾	All pins		kV
	Charged-device Model (CDM) ⁽³⁾	-750	750	V

(1) Electrostatic discharge (ESD) to measure device sensitivity and immunity to damage caused by assembly line electrostatic discharges into the device.

(2) Level listed above is the passing level per ANSI, ESDA, and JEDEC JS-001. JEDEC document JEP155 states that 500-V HBM allows safe manufacturing with a standard ESD control process.

(3) Level listed above is the passing level per EIA-JEDEC JESD22-C101. JEDEC document JEP157 states that 250-V CDM allows safe manufacturing with a standard ESD control process.

7.4 Recommended Operation Conditions

		MIN	TYP	MAX	UNIT
V _{BUS}	V _{BUS} voltage range	3.9		13.5	V
V _{BAT}	V _{BAT} voltage range		4.2	4.848	V
I _{IN}	Input current limit			3.25	A



I _{cc}	Constant current charge current (SW Output Current)			5	A
I _{bis}	Discharging current continuous	6			A
	Discharging current (1s)	10			
L	Inductance		1		μH
T _A	Operating ambient temperature	-40		85	°C
T _J	Operating junction temperature	-40		125	°C



8 Function Block Diagram

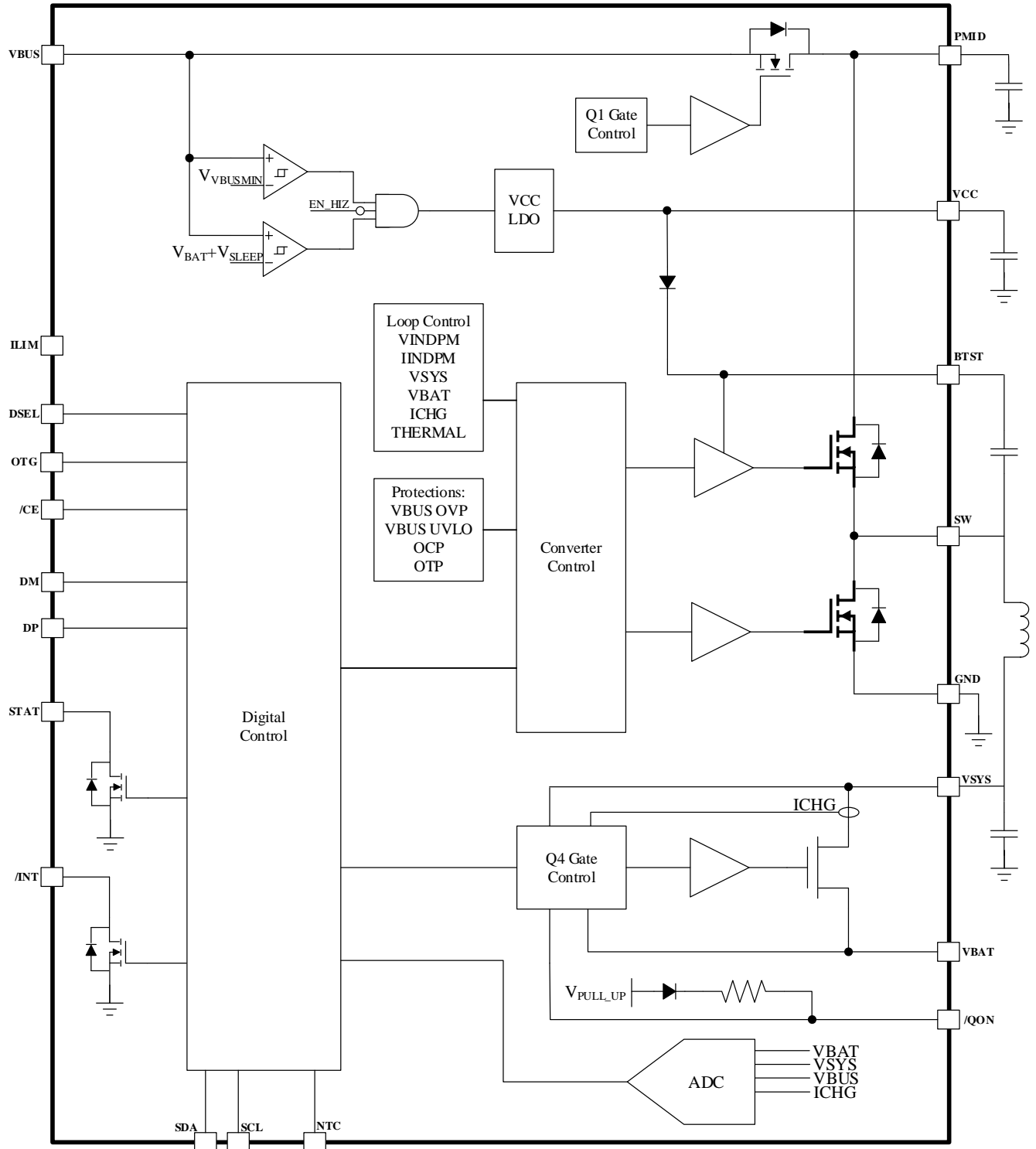



9 Electrical Characteristics

$T_A = 25\text{ }^\circ\text{C}$ and $V_{AC_UVLO} < V_{BUS} < V_{VAC_OVP}$, unless otherwise noted.

PARAMETER	TEST CONDITIONS	MIN	TYP	MAX	UNIT	
SUPPLY VOLTAGE						
V_{BUS}	Operating input V_{BUS} voltage	3.9		13.5	V	
V_{VBUS_UVLO}	V_{BUS} for active I2C, no battery	Rising edge	3.3		V	
		Hysteresis	300		mV	
V_{SLEEP}	$V_{BUS}-V_{BAT}$ threshold	Falling edge	20	100	210	mV
		Rising edge	120	220	370	mV
V_{VAC_OVP}	V_{BUS} Over Voltage threshold	Rising edge	13.5	14.2	14.9	V
		Hysteresis		300		mV
V_{VBAT_UVLO}	BAT for active I2C, no V_{BUS}	Rising edge	2.25			V
		Hysteresis		240		mV
V_{VBAT_DPL}	Battery Depletion threshold	Rising edge	2.5	2.6	2.75	V
		Hysteresis		200		mV
$V_{VBUSMIN}$	Bad adapter detection threshold	Falling edge	3.6	3.7	3.8	V
		Hysteresis		200		mV
I_{BADSRC}	Bad adapter detection sink current from V_{BUS} to GND		30		mA	
I_{BAT}	Battery discharge current in Buck mode	$V_{BAT} = 4.5\text{ V}$, HIZ mode, no V_{BUS} , BATFET_DIS Enable ,ADC Disable	15	25	uA	
		$V_{BAT} = 4.5\text{ V}$, HIZ mode, no V_{BUS} , BATFET_DIS Disable ,ADC Disable	22	35	uA	
I_{VBUS_HIZ}	Input supply current in buck mode when HIZ mode is enabled	$V_{BUS}=5\text{V}$, HIZ mode and BATFET_DIS Disable, no battery		40	uA	
		$V_{BUS}=12\text{V}$,HIZ mode and BATFET_DIS Disable, no battery		60	uA	
I_{VBUS}	Input supply current in buck mode	$V_{BUS} > V_{VBUS_UVLO}$, $V_{BUS}>V_{BAT}$, Converter not switching	1.5	3	mA	
		$V_{BUS} > V_{VBUS_UVLO}$, $V_{BUS}>V_{BAT}$, Converter switching, $V_{BAT}=3.8\text{V}$, $I_{SYS}=0\text{A}$, disable charger	3		mA	
I_{BOOST}	Battery discharge current in boost mode	$V_{BAT}=4.2\text{V}$,boost mode, $I_{VBUS}=0\text{A}$, converter switching		3	mA	
POWER PATH						
V_{SYS}	Typical system regulation voltage	$I_{SYS}=0\text{A}$, $V_{BAT}<V_{SYSMIN}$, $I_{SYS}=0\text{A}$, BATFET Disable		$V_{SYSMIN}+0.18$	V	
V_{SYS_MIN}	Minimum system regulation voltage	$V_{VBAT} < V_{SYS_MIN} = 3.5\text{V}$, BATFET Disabled	3.55	3.68	V	
		Range	3	3.7	V	
V_{SYS_MAX}	Maximum DC system voltage output	$I_{SYS}=0\text{A}$, $V_{BAT}>V_{SYSMIN}$, $I_{SYS}=0\text{A}$, BATFET Disable, $V_{VBAT}<=4.4\text{V}$	4.4	4.45	4.51	V



R _{DSON_Q1}	Reverse blocking MOSFET on resistance	V _{CC} =5V	35	46	mΩ	
R _{DSON_Q2}	High side switching MOSFET on resistance	V _{CC} =5V	38	46	mΩ	
R _{DSON_Q3}	Low side switching MOSFET on resistance	V _{CC} =5V	25	36	mΩ	
R _{DSON_Q4}	V _{SYS} to V _{BAT} MOSFET on resistance	V _{VBAT} =4.2V	17	25	mΩ	
V _{FWD}	Supplement mode Q4 forward voltage		50		mV	
CHARGER MANAGEMENT						
V _{BATREG_RANGE}	Regulation Charge Voltage		3.84	4.848	V	
V _{BATREG_STEP}	Charge Voltage Step		16		mV	
V _{BATREG_ACC}	Charge Voltage accuracy	V _{BATREG} =4.208V	4.18	4.208	4.23	V
		V _{BATREG} =4.384V	4.36	4.384	4.4	V
		V _{BATREG} =4.432V	4.4	4.432	4.45	V
I _{CC_RANGE}	Constant charging current range		0	5.04	A	
I _{CC_STEP}	Constant charging current step		60		mA	
I _{CC_ACC}	Constant charging current accuracy	I _{CC} =240mA, V _{BAT} = 3.8V	216	240	264	mA
		I _{CC} =720mA, V _{BAT} = 3.8V	684	720	756	mA
		I _{CC} =2040mA, V _{BAT} = 3.8V	1938	2040	2142	mA
		I _{CC} =3000mA, V _{BAT} = 3.8V	2850	3000	3150	mA
V _{TC}	Trickle charge to CC Charge battery voltage threshold	Rising edge	2.9	3	3.1	V
		Hysteresis		200		mV
I _{TC_RANGE}	Trickle charge current range		60	960	mA	
I _{TC_STEP}	Trickle charge current step		60		mA	
I _{TC_ACC}	Trickle charge current accuracy	I _{TC} =120mA	90	120	150	mA
		I _{TC} =420mA	390	420	450	mA
I _{TERM_RANGE}	Termination current range		30	930	mA	
I _{TERM_STEP}	Termination current step		60		mA	



I _{TERM_ACC}	Termination current accuracy	I _{TERM} =120mA	90	120	150	mA
		I _{TERM} =240mA	216	240	264	mA
		I _{TERM} =420mA	390	420	450	mA
V _{BAT_SHORT}	Battery short voltage	Falling edge	1.85	2	2.15	V
		Hysteresis		200		mV
I _{BAT_SHORT}	Battery short charge current	V _{BAT} =1V	35	50	65	mA
V _{RECHG}	Recharge threshold below V _{BAT_REG}	V _{BAT} falling edge, 100mV	80	100	140	mV
		V _{BAT} falling edge, 200mV	170	200	250	mV
I _{SYSLD}	System discharge load current	V _{SYS} =4.2V		30		mA
t _{TERM_DGL}	Deglintch time for charge termination			250		ms
t _{RECH_DGL}	Deglintch time for recharge			20		ms
I _{BAT_OCP_DGL}	System over-current(10A) deglintch time to turn off Q4			100		us
t _{SYSOVP_DGL}	System over-voltage deglintch time to turn off DCDC			1		us
t _{BATOV_P_DGL}	Battery over-voltage deglintch time to disable charger			1		us
INPUT VOLTAGE AND CURRENT REGULATION						
V _{INDPM_RANGE}	Input voltage regulation limit range		3.9		15.3	V
V _{INDPM_STEP}	Input voltage regulation limit step			100		mV
V _{INDPM_ACC}	Input voltage regulation limit accuracy	V _{INDPM} =4.8V	4.6	4.8	4.944	V
		V _{INDPM} =8.2V	7.9	8.4	8.5	V
V _{INDPM_OS}	V _{INDPM} =V _{BUS} - V _{INDPM_OS}	V _{INDPM_OS} =400mV		400		mV
		V _{INDPM_OS} =600 mV		600		mV
I _{INDPM_RANGE}	Input current regulation limit range		100		3250	mA
I _{INDPM_STEP}	Input current regulation limit step			50		mA
I _{INDPM_ACC}	Input current regulation limit accuracy	V _{BUS} =5V, I _{INDPM} =500 mA	410		500	mA
		V _{BUS} =5V, I _{INDPM} =900 mA	750		900	mA
		V _{BUS} =5V, I _{INDPM} =1500 mA	1300		1500	mA



		$V_{BUS} = 5V, I_{INDPM} = 2400\text{ mA}$	2200	2400		mA
I_{IN_START}	Input current limit during system start-up sequence		200			mA
K_{ILM}	$I_{INMAX} = K_{ILM} / R_{ILM}$	Input current regulation by ILIM pin = 1.5 A	310	350	385	A x Ω
PROTECTION						
V_{VBAT_OVP}	Battery over voltage threshold	Rising	102	104	105	%
		Hysteresis		2		%
I_{BAT_OCP}	Battery discharge over current threshold	100 μ s deglitch	10			A
PWM						
f_{SW}	PWM switching frequency	$V_{BUS} = 9V, V_{BAT} = 4V, I_{CC} = 3A$	1250	1500	1680	KHz
D_{MAX}	Maximum PWM duty cycle(Buck)			97%		
JEITA (BUCK MODE)						
V_{COLD}	NTC cold temp (0°C) threshold, as percentage of VCC	Rising	72.4	73.3	74.2	%
		falling	71.5	72	72.5	%
V_{COOL}	NTC cool temp threshold, as percentage of VCC	5°C Rising	70.25	70.75	71.25	%
		5°C falling	68.7	69.2	69.7	%
		10°C Rising	67.75	68.25	68.75	%
		10°C falling	66.45	66.95	67.45	%
		15°C Rising	64.75	65.25	65.75	%
		15°C falling	63.7	64.2	64.7	%
		20°C Rising	61.75	62.25	62.75	%
		20°C falling	60.7	61.2	61.7	%
V_{WARM}	NTC warm temp threshold, as percentage of VCC	40°C Falling	47.74	48.25	48.75	%
		40°C Rising	48.8	49.3	49.8	%
		45°C Falling	44.25	44.75	45.25	%
		45°C Rising	45.3	45.8	46.3	%
		50°C Falling	40.2	40.7	41.2	%
		50°C Rising	41.3	41.8	42.3	%
		55°C Falling	37.2	37.7	38.2	%
		55°C Rising	38.5	39	39.5	%
V_{HOT}	NTC hot temp (60°C) threshold, as percentage of VCC	Falling	33.7	34.2	34.7	%
		Rising	34.8	35.3	35.8	%
I_{RATIO_COOL}	Charging current during JEITA COOL as percentage of I_{CC}	20%		20		%
		50%		50		%
I_{RATIO_WARM}	Charging current during JEITA WARM as percentage of I_{CC}	20%		20		%
		50%		50		%



V _{DELTA_WARM}	V _{BAT} regulation voltage in JEITA WARM equal to V _{BATREG} - V _{DELTA_WARM}	100mV	100		mV	
		200mV	200		mV	
NTC (BOOST MODE)						
V _{BCOLD}	NTC cold temp threshold, as percentage of VCC	Rising	79.5	80	80.5	%
		falling	78.5	79	79.5	%
V _{BHOT}	NTC hot temp threshold, as percentage of VCC	Falling	29.7	31.2	32	%
		Rising	33.9	34.4	34.9	%
BOOST MODE OPERATION						
V _{OTG_REG_RANGE}	Boost mode regulation voltage range		3.9	5.4	V	
V _{OTG_REG_STEP}	Boost mode regulation voltage step		100		mV	
V _{OTG_REG_ACC}	Boost mode regulation voltage accuracy	V _{OTG_REG} =5V, V _{BAT} =3.8V, I _{BUS} =0A	4.85	5	5.15	V
		V _{OTG_REG} =5.2V, V _{BAT} =3.8V, I _{BUS} =0A	5.04	5.2	5.36	V
V _{VBATLOW_OTG}	Battery voltage exiting boost mode	V _{VBAT} falling,2.8V	2.7	2.8	2.9	V
		Hysteresis		200		mV
		V _{VBAT} falling,2.5V	2.4	2.5	2.6	V
		Hysteresis		300		mV
I _{OTG_RANGE}	OTG mode output current limit range		0.5	2.45	A	
I _{OTG_ACC}	OTG mode output current limit accuracy	I _{OTG} =1.2A	1.2	1.4	1.6	A
V _{OTG_OVP}	OTG overvoltage threshold	Rising	5.8		V	
VCC LDO						
V _{VCC}	V _{CC} LDO output voltage	V _{BUS} =9V, I _{VCC} =20mA	5		V	
I _{VCC}	V _{CC} current limiter	V _{BUS} =5V, V _{VCC} = 3.8V, Charger disable	50		mA	
LOGIC IO						
V _{ILO}	Input low threshold			0.4	V	
V _{IHO}	Input high threshold		0.9		V	
/QON TIMING						
t _{SHIPMODE}	/QON low time to turn on BATFET and exit ship mode		0.9	1.3	s	
t _{QON_RST}	/QON low time to reset BATFET		8	12	s	
t _{BATFET_RST}	BATFET off time during full system reset		250	400	ms	
t _{BATFET_DLY}	Enter ship mode delay		10	15	s	
DIGITAL CLOCK AND WATCHDOG TIMER						
t _{WDT}	Watchdog timer		40		s	
f _{SCL}	SCL Clock frequency			400	KHz	



SAFETY TIMER						
t_{TC}	Safety timer for Trickle charge		4			hours
$t_{CC/CV}$	Safety timer for CC and CV		12			hours
VBUS Power up						
t_{VAC_OVP}	V_{BUS} OVP reaction time		100			ns
t_{BADSRC}	Bad adapter detection duration		30			ms
THERMAL REGULATION and SHUTDOWN						
T_{REG}	Thermal regulation temperature	Range	60	120		°C
		Step		20		°C
T_{SD}	Thermal shutdown temperature		150			°C
	Thermal shutdown hysteresis		30			°C
DP/DM Detection						
V_{0P6_VSRC}	DP/DM voltage source		0.5	0.6	0.7	V
V_{1P2_VSRC}	DP/DM voltage source		1.1	1.2	1.3	V
V_{2P0_VSRC}	DP/DM voltage source		1.9	2	2.1	V
V_{2P7_VSRC}	DP/DM voltage source		2.6	2.7	2.8	V
V_{3P3_VSRC}	DP/DM voltage source		3.2	3.3	3.4	V
V_{0P325_VTH}	DP/DM Input comparator threshold		0.25		0.4	V
V_{1P0_VTH}	DP/DM Input comparator threshold		0.9	7	1.1	V
V_{1P35_VTH}	DP/DM Input comparator threshold		1.25		1.45	V
V_{2P2_VTH}	DP/DM Input comparator threshold		2.1		2.3	V
V_{3P0_VTH}	DP/DM Input comparator threshold		2.9		3.1	V
I_{DP/DM_SRC}	BC1.2 DP/DM source capability	0.6V output	250			μA
		3.3V output	250			μA
R_{DP/DM_PD}	DP/DM pull down resistor		19.53			KΩ
I_{DP/DM_SINK}	BC1.2 DP/DM sink current		50			μA
Pump Current Pulse						
t_{PUMPX_STOP}	Current pulse control stop pulse		430	570		ms
t_{PUMPX_ON1}	Current pulse control long on pulse		240	360		ms
t_{PUMPX_ON2}	Current pulse control short on pulse		70	130		ms
t_{PUMPX_OFF}	Current pulse control off pulse		70	130		ms



t_{PUMPX_DLY}	Current pulse control stop start delay		80	225	ms
DSEL					
V_{OL}	Output low threshold level	$C_{DSEL}=47nF$		0.4	V
V_{OH}	Output high threshold level	$C_{DSEL}=47nF$	4.5		V
IR COMP					
Resistance		Range	0	140	mΩ
		Step		20	mΩ
V_{CLAMP}		Range	0	224	mV
		Step		32	mV



10 Feature Description

10.1 Power-On-Reset(POR)

The SC89890H powers internal bias circuits from the higher voltage of VBUS and VBAT. When VBUS rises above V_{VBUS_UVLO} or VBAT rises above V_{VBAT_UVLO} , the sleep comparator, battery depletion comparator and BATFET driver are active. I2C interface is ready for communication and all the registers are reset to default value. The host can access all the registers after POR.

10.2 Device Power Up from Battery without Input Source

If only battery is present and the voltage is above depletion threshold, the BATFET turns on and connects battery to system. The VCC LDO stays off to minimize the quiescent current. The low $R_{DS(on)}$ of BATFET and the low quiescent current on BAT minimize the conduction loss and maximize the battery run time.

The device always monitors the discharge current through BATFET (Supplement Mode). When the system is overloaded or shorted ($I_{BAT} > I_{BAT_OCP}$), the device turns off BATFET immediately and set BATFET_DIS bit to indicate BATFET is disabled until the input source plugs in again or one of the methods described in BATFET Enable (Exit Shipping Mode) is applied to re-enable BATFET.

10.3 Power Up from Input Source

When an input source is plugged in, the device checks the input source voltage to turn on VCC LDO and all the bias circuits. It detects and sets the input current limit before the buck converter is started. The power up sequence from input source is as listed:

1. Power up VCC LDO
2. Poor Source Qualification
3. Input Source Type Detection is based on DP/DM to set default input current limit (IINDPM) register or input source type
4. Input Voltage Limit Threshold Setting (VINDPM threshold)
5. Converter Power-up

10.3.1 Power Up VCC LDO Regulation

The VCC LDO supplies internal bias circuits as well as the HSFET and LSFET gate drive. The VCC also provides bias rail to NTC external resistors. The pull-up rail of STAT can

be connected to VCC as well. The VCC is enabled when all the below conditions are valid:

- V_{BUS} above $V_{VBUSMIN}$, above $V_{BAT} + V_{SLEEP}$ in buck mode
- V_{BUS} below $V_{BAT} + V_{SLEEP}$ in boost mode
- Above conditions are satisfied during 220ms delay

If any one of the above conditions is not valid, the device is in high impedance mode (HIZ) with VCC LDO off. The device draws less than I_{VBUS_HIZ} from VBUS during HIZ state. The battery powers up the system when the device is in HIZ mode.

By setting EN_HIZ bit to 1 with adapter, the device enters high impedance state (HIZ). In HIZ mode, the system is powered from battery even with good adapter present. The device is in the low input quiescent current state with Q1 RBFET, VCC LDO and the bias circuits off.

10.3.2 Poor Source Qualification

After VCC LDO powers up, the device confirms the current capability of the input source. The input source must meet both of the following requirements in order to start the buck converter:

- VBUS voltage below V_{VAC_OVP}
- VBUS voltage above $V_{VBUSMIN}$ when pulling I_{BADSRC} (typical 30 mA)

Once the input source passes all the conditions above, the status register bit VBUS_GD is set high and the /INT pin is pulsed to signal to the host. If the device fails the poor source detection, it repeats poor source qualification every 2 seconds.

10.3.3 Input Source Type Detection

After the VBUS_GD bit is set and VCC LDO is powered, the device runs input source detection through DP/DM. The SC89890H follows the USB Battery Charging Specification 1.2 (BC1.2) to detect input source (SDP/CDP/DCP) and non-standard adapter through USB DP/DM lines.

After input source type detection is completed, an INT pulse is asserted to the host. In addition, the following registers and pin are changed:

1. Input Current Limit (IINDPM) register is changed to set current limit
2. PG_STAT bit is set
3. VBUS_STAT bit is updated to indicate USB or other input source



The host can over-write IINDPM register to change the input current limit if needed. The charger input current is always limited by the IINDPM register. The charger input current is always limited by the lower of IINLIM register or ILIM pin at all-time regardless of Input Current Optimizer (ICO) is enable or disabled.

When AUTO_DPDM_EN is disabled, the Input Source Type Detection is bypassed.

The SC89890H contains a DP/DM based input source detection to set the input current limit at VBUS plug-in. The DP/DM detection includes standard USB BC1.2 and non-standard adapter. When input source is plugged in, the device starts standard USB BC1.2 detection. The USB BC1.2 is capable to identify Standard Downstream Port (SDP), Charging Downstream Port (CDP) and Dedicated Charging Port (DCP). When the Data Contact Detection (DCD) timer expires, the nonstandard adapter detection is applied to set the input current limit. The non-standard detection is used to distinguish vendor specific adapters (Apple and Samsung) based on their unique dividers on the DP/D- pins. If an adapter is detected as DCP, the input current limit is set at 3.25 A. If an adapter is detected as unknown, the input current limit is set at 0.5 A.

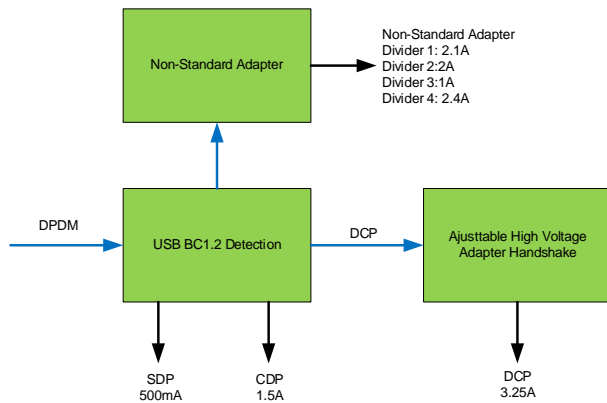

Figure1 USB DP/DM Detection

DP/DM DETECTION	INPUT CURRENT LIMIT
USB SDP	500mA
USB CDP	1.5A
USB DCP	3.25A
Divider 1	2.1A
Divider 2	2A
Divider 3	1A
Divider 4	2.4A
Unknown Adapter	500mA

Table1 Input current limit setting from DP/DM Detection

10.3.4 Input Voltage Limit Threshold Setting

The device supports wide range of input voltage limit (3.9 V – 14 V) for high voltage charging and provides two methods to set Input Voltage Limit (VINDPM) threshold to facilitate autonomous detection.

1. Absolute VINDPM (FORCE_VINDPM=1)

By setting FORCE_VINDPM bit to 1, the VINDPM threshold setting algorithm is disabled. Register VINDPM is writable and allows host to set the absolute threshold of VINDPM function.

2. Relative VINDPM based on VINDPM_OS registers (FORCE_VINDPM=0)

When FORCE_VINDPM bit is 0 (default), the VINDPM threshold setting algorithm is enabled. The VINDPM register is read only and the charger controls the register by using VINDPM threshold setting algorithm (VBUS-VINDPM_OS).

After Input Voltage Limit Threshold is set, an INT pulse is generated to signal to the host

10.3.5 Converter Power-Up

After the input current limit is set, the converter is enabled and the HSFET and LSFET start switching. If battery charging is disabled, BATFET turns off. Otherwise, BATFET stays on to charge the battery.

The SC89890H provides soft-start when system rail is ramped up. When the system rail is below 2.2 V, the input current is limited to is to the lower of 200 mA or IINDPM



register setting. After the system rises above 2.2 V, the device limits input current to the value set by IINDPM register.

As a battery charger, the device deploys a highly efficient 1.5 MHz step-down switching regulator. The fixed frequency oscillator keeps tight control of the switching frequency under all conditions of input voltage, battery voltage, charge current and temperature, simplifying output filter design.

The SC89890H switches to PFM control at light load or when battery is below minimum system voltage setting or charging is disabled.

10.4 Boost Mode Operation From Battery

The SC89890H supports boost converter operation to deliver power from the battery to other portable devices through USB port. The boost mode output current rating meets the USB On-The-Go 500 mA output requirement. The maximum output current is up to 2.4 A. The boost operation can be enabled if the conditions are valid:

1. VBAT above $V_{VBATLOW_OTG}$
2. VBUS less than VBAT + V_{SLEEP}
3. Set OTG_CONFIG and OTG Pin high
4. Battery is not in BCOLD and BHOT.
5. Above conditions are satisfied during 30ms delay.

During boost mode, the status register VBUS_STAT bits is set to 111, the VBUS output is 5 V and the output current can reach up to 2.4 A, selected through I2C (I_{BOOST} bit). The boost output is maintained when BAT is above $V_{VBATLOW_OTG}$ threshold.

In boost mode, the device employs a 500 KHz or 1.5 MHz (selectable using BOOST_FREQ bit) step-up switching regulator based on system requirements. To avoid frequency change during boost mode operations, write to boost frequency configuration bit (BOOST_FREQ) is ignored when OTG_CONFIG is set.

When OTG is enabled, the device starts up with PFM and later transits to PWM to minimize the overshoot. The PFM_OTG_DIS bit can be used to prevent PFM operation in either buck or boost configuration.

10.5 Host Mode and Default Mode

The SC89890H is a host controlled charger, but it can operate in default mode without host management. In default mode, the device can be used as an autonomous charger with no host or while host is in sleep mode.

When the charger is in default mode, WATCHDOG_FAULT bit is HIGH. When the charger is in host mode, WATCHDOG_FAULT bit is LOW.

After power-on-reset, the device starts in default mode with watchdog timer expired, or default mode. All the registers are in the default settings. In default mode, the device keeps charging the battery with default 10-hour fast charging safety timer. At the end of the 10-hour, the charging is stopped and the buck converter continues to operate to supply system load.

Writing reg transitions the charger from default mode to host mode. All the device parameters can be programmed by the host. To keep the device in host mode, the host has to reset the watchdog timer by writing 1 to WD_RST bit before the watchdog timer expires (WATCHDOG_FAULT bit is set), or disable watchdog timer by setting WATCHDOG bits = 00.

When the watchdog timer expires (WATCHDOG_FAULT bit = 1), the device returns to default mode and all registers are reset to default values except IINDPM, VINDPM, VINDPM_OS, BATFET_RST_EN, BATFET_DLY, and BATFET_DIS bits.

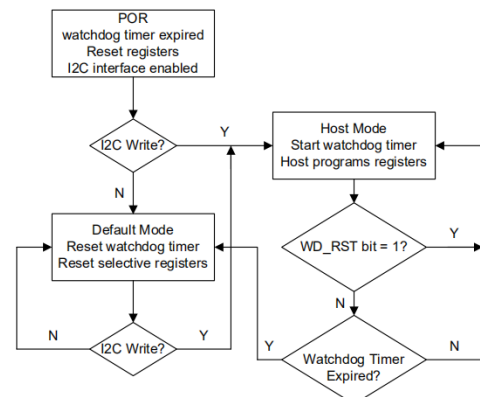

Figure2 Watch dog

10.6 ICO

The device provides innovative Input Current Optimizer (ICO) to identify maximum power point without overload the input source. The algorithm automatically identify maximum input current limit of power source without entering VINDPM to avoid input source overload.

This feature is enabled by default (ICO_EN=1) and can be disabled by setting ICO_EN bit to 0. After DCP type input source is detected based on the procedures previously The algorithm runs automatically when ICO_EN bit is set. The algorithm can also be forced to execute by setting FORCE_ICO bit regardless of input source type detected.



The actual input current limit used by the Dynamic Power Management is reported in IDPM_LIM register while Input Current Optimizer is enabled (ICO_EN = 1) or set by IINLIM register when the algorithm is disabled (ICO_EN = 0). In addition, the current limit is clamped by ILIM pin unless EN_ILIM bit is 0 to disable ILIM pin function.

10.7 NVDC Power Path Management

The SC89890H accommodates a wide range of input sources from USB, wall adapter, to car charger. The device provides automatic power path selection to supply the system (VSYS) from input source (VBUS), battery (VBAT), or both.

10.7.1 Battery Charging Management

The SC89890H charges 1-cell Li-Ion battery with up to 5A charge current for high capacity tablet battery. The low R_{dson} BATFET improves charging efficiency and minimize the voltage drop during discharging.

10.7.1.1 Autonomous Charging Cycle

With battery charging is enabled (CHG_CONFIG bit = 1 and /CE pin is LOW), the device autonomously completes a charging cycle without host involvement. The host can always control the charging operations and optimize the charging parameters by writing to the corresponding registers through I2C.

Charging Parameters	Default Value
Charging Voltage	4.208V
CC Current	2.040A
TC Current	120mA
Termination Current	270mA
Battery Temperature Profile	JEITA
Safety Timer	TC:4hours, CC/CV:12hours

Table2 Charging Parameter Default Setting

A new charge cycle starts when the following conditions are valid:

- Converter starts
- Battery charging is enabled (CHG_CONFIG bit =1, I_{CC} is not 0A and /CE is low)
- No NTC COLD or HOT fault
- No safety timer fault
- BATFET is not forced to turn off (BATFET_DIS bit=0)

The charger device automatically terminates the charging cycle when the charging current is below termination threshold, battery voltage is above recharge threshold, and device not is in DPM mode or thermal regulation. When a fully charged battery is discharged below recharge threshold (selectable through VRECHG bit), the device automatically starts a new charging cycle. After the charge is done, toggle CE pin or CHG_CONFIG bit can initiate a new charging cycle. Adapter removal and re plug will also start a new charging cycle.

The STAT output indicates the charging status: charging (LOW), charging complete or charge disable (HIGH) or charging fault (Blinking). The STAT output can be disabled by setting STAT_DIS=1. In addition, the status register (CHRG_STAT) indicates the different charging phases: 00-charging disable, 01-precharge, 10-fast charge (constant current) and constant voltage mode, 11-charging done. Once a charging cycle is completed, an INT is asserted to notify the host.

STAT status	IC working status
Low	Normal charging (TC/CC/CV/Recharge)
High	End of charging (EOC, top off timer maybe running) , charge disable, sleep mode, Boost Mode
1Hz Blinking	Charge suspend(VBUS OVP, NTC COLD/HOT, Safety timer out, VBAT OVP). Boost Mode suspend(NTC/COLD/HOT)

Table3 STAT Pin status

10.7.1.2 Battery Charging Profile

The SC89890H charges the battery in five phases: battery short, TC,CC,CV, and top-off trickle charging (optional). At the beginning of a charging cycle, the device checks the battery voltage and regulates current and voltage accordingly.

V _{VBAT}	Charging current	Default value	CHRG_STAT
< V _{BAT_SHORT}	I _{BAT_SHORT}	50mA	01
V _{BAT_SHORT} to V _{TC}	I _{TC}	120mA	01
> V _{TC}	I _{CC}	2.040A	10

Table4 Charging Current Setting

If the charger device is in DPM regulation or thermal regulation during charging, the actual charging current will be less than the programmed value. In this case, termination is temporarily disabled and the charging safety timer is doubled.

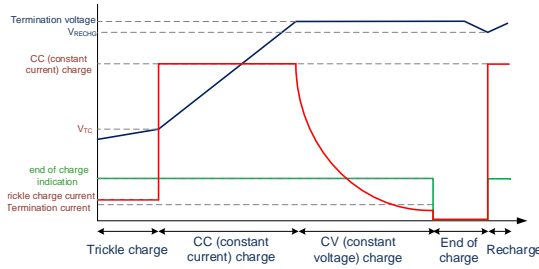

Figure3 Battery Charging Profile

10.7.1.3 End of Charge

The SC89890H terminates a charge cycle when the battery voltage is above recharge threshold, and the current is below termination current. After the charging cycle is completed, the BATFET turns off. The converter keeps running to power the system, and BATFET can turn on again to engage Supplement Mode.

When termination occurs, the status register CHRГ_STAT is set to 11, and an INT pulse is asserted to the host. Termination is temporarily disabled when the charger device is in input current, voltage or thermal regulation. Termination can be disabled by writing 0 to EN_TERM bit prior to charge termination.

10.7.1.4 NTC in Buck mode

The SC89890H monitors the battery cells' temperature through NTC pin. It monitors the NTC voltage. Once it detects the temperature is below 0°C or higher than 60°C, the IC will stop charging. Below shows the NTC operation summary.

Table5 NTC function

V _{NTC}	Temperature	Operation
V _{NTC} > V _{COLD}	T < 0°C	Stop charging
V _{COLD} > V _{NTC} > V _{COOL}	0°C < T < 10°C	0/0.5/0.2/1 CC current
V _{COOL} > V _{NTC} > V _{WARM}	10°C < T < 45°C	Normal charging
V _{WARM} > V _{NTC} > V _{HOT}	45°C < T < 60°C	CV/CV-50mV/CV-100mV/CV-200mV 0/0.5/0.2/1 CC current

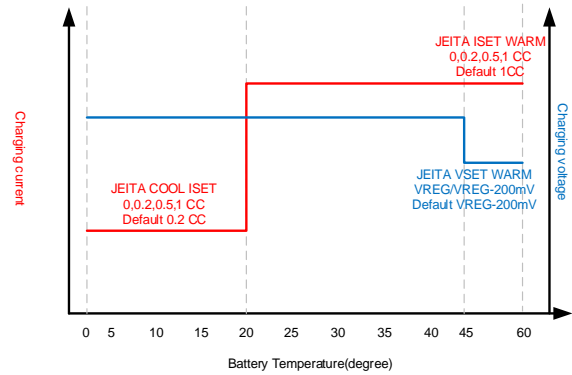

Figure4 NTC function

10.7.1.5 NTC in Boost mode

For battery protection during boost mode, the SC89890H monitors the battery temperature to be within the V_{BCOLD} to V_{BHOT} thresholds. When temperature is outside of the temperature thresholds, the boost mode is suspended. In addition, V_{BUS_STAT} bits are set to 000 and NTC_FAULT is reported. Once temperature returns within thresholds, the boost mode is recovered and NTC_FAULT is cleared.

10.7.1.6 Safety Timer

The SC89890H has built-in safety timer to prevent extended charging cycle due to abnormal battery conditions. The safety timer is 4 hours when the battery is below V_{TC} threshold and 12 hours when the battery is higher than V_{TC} threshold.

The user can program CC/CV charge safety timer through I2C (CHG_TIMER bits). When safety timer expires, the fault register CHRГ_FAULT bits are set to 11 and an INT is asserted to the host. The safety timer feature can be disabled through I2C by setting EN_TIMER bit.

During input voltage, current, JEITA cool/warm or thermal regulation, the safety timer will double as the setting value. The timer double function can be disabled by writing 0 to TMR2X_EN bit.

During the fault(BAT_FAULT,NTC_FAULT), timer is suspended. Once the fault goes away, timer resumes. If user stops the current charging cycle, and start again, timer gets reset (toggle /CE pin or CHR_CONFIG bit).

10.7.2 Resistance Compensation

For high current charging system, resistance between charger output and battery cell terminal such as board routing, connector, MOSFETs and sense resistor can force



the charging process to move from constant current to constant voltage too early and increase charge time. To speed up the charging cycle, the device provides resistance compensation (IRCOMP) feature which can extend the constant current charge time to delivery maximum power to battery.

The device allows the host to compensate for the resistance by increasing the voltage regulation set point based on actual charge current and the resistance as shown below. For safe operation, the host should set the maximum allowed regulation voltage register (V_{CLAMP}) and the minimum resistance compensation (BAT_COMP).

$$V_{REG_ACTUAL} = V_{REG} + \min(I_{CHRG_ACTUAL} \times BAT_COMP, V_{CLAMP})$$

10.7.3 Battery Monitor

The device includes a battery monitor to provide measurements of VBUS voltage, VBUS current, battery voltage, system voltage, ntc ratio and charging current based on the device modes of operation. The measurements are reported in Battery Monitor Registers (REG0E-REG12). The battery monitor can be configured as two conversion modes by using CONV_RATE bit: one-shot conversion (default) and 1 second continuous conversion.

For one-shot conversion (CONV_RATE = 0), the CONV_START bit can be set to start the conversion. During the conversion, the CONV_START is set and it is cleared by the device when conversion is completed. The conversion result is ready after t_{CONV} (maximum 1 second).

For continuous conversion (CONV_RATE = 1), the CONV_RATE bit can be set to initiate the conversion. During active conversion, the CONV_START is set to indicate conversion is in progress. The battery monitor provides conversion result every 1 second automatically. The battery monitor exits continuous conversion mode when CONV_RATE is cleared.

When battery monitor is active, the VCC power is enabled and can increase device quiescent current. In battery only mode, the battery monitor is only active when $V(BAT) > SYS_MIN$ setting .

10.7.4 Input Current Limit on ILIM

For safe operation, the device has an additional hardware pin on ILIM to limit maximum input current on ILIM pin. The input maximum current is set by a resistor from ILIM pin to ground as:

$$I_{INMAX} = \frac{K_{ILIM}}{R_{ILIM}}$$

The actual input current limit is the lower value between ILIM setting and register setting (IINLIM). For example, if the register setting is 111111 for 3.25 A, and ILIM has a 260-Ω resistor ($K_{ILIM} = 390$ max.) to ground for 1.5 A, the input current limit is 1.5 A. ILIM pin can be used to set the input current limit rather than the register settings when EN_ILIM bit is set. The device regulates ILIM pin at 0.8 V. If ILIM voltage exceeds 0.8 V, the device enters input current regulation.

The ILIM pin can also be used to monitor input current when EN_ILIM is enabled. The voltage on ILIM pin is proportional to the input current. ILIM pin can be used to monitor the input current following Equation:

$$I_N = \frac{K_{ILIM} \times V_{ILIM}}{R_{ILIM} \times 0.8 V}$$

For example, if ILIM pin is set with 260-Ω resistor, and the ILIM voltage is 0.4 V, the actual input current 0.615 A - 0.75 A (based on KILM specified). If ILIM pin is open, the input current is limited to zero since ILIM voltage floats above 0.8 V. If ILIM pin is short, the input current limit is set by the register.

The ILIM pin function can be disabled by setting EN_ILIM bit to 0. When the pin is disabled, both input current limit function and monitoring function are not available.

10.7.5 Current Pulse Protocol

The device provides the control to generate the VBUS current pulse protocol to communicate with adjustable high voltage adapter in order to signal adapter to increase or decrease output voltage. To enable the interface, the EN_PUMPX bit must be set. Then the host can select the increase/decrease voltage pulse by setting one of the PUMPX_UP or PUMPX_DN bit (but not both) to start the VBUS current pulse sequence. During the current pulse sequence, the PUMPX_UP and PUMPX_DN bits are set to indicate pulse sequence is in progress and the device pulses the input current limit between current limit set forth by IINLIM or IDPM_LIM register and the 100mA current limit (IINDPM100_ACC). When the pulse sequence is completed, the input current limit is returned to value set by IINLIM or IDPM_LIM register and the PUMPX_UP or PUMPX_DN bit is cleared. In addition, the EN_PUMPX can be cleared during the current pulse sequence to terminate the sequence and force charger to return to input current limit as set forth by the IINLIM or IDPM_LIM register immediately. When EN_PUMPX bit is low, write to PUMPX_UP and PUMPX_DN bit would be ignored and have no effect on VBUS current limit.



If the load in VBUS (including battery charging) less than 100mA, the current pulse may not work.

10.7.6 DP/DM DAC

The device provides independent controlled voltage output drivers on DP and DM pins to interface or emulate non-standard adapters when input source is plugged-in or OTG mode is enabled. The DP/DM drivers are disabled in high impedance mode (HiZ) by default or when DP or DM Control bits are set to be HiZ.

The drivers are enabled and controlled independently with predefined voltage threshold(HiZ, Short also supported)

The host is recommended to change DP and DM settings after input source type detection when VBUS_STAT/PG_STAT bits are updated.

When OTG mode is enabled, the drivers can be enabled to provide electrical signature on DP/DM to emulate USB non-standard adapters

10.7.7 NVDC Architecture

The SC89890H deploys Narrow VDC architecture (NVDC) with BATFET separating system from battery. The minimum system voltage is set by V_{SYS_MIN} bits. Even with a fully depleted battery, the system is regulated above the minimum system voltage.

When the battery is below minimum system voltage setting, the BATFET operates in linear mode (LDO mode), and the system is typically 180 mV above the minimum system voltage setting. As the battery voltage rises above the minimum system voltage, BATFET is fully on and the voltage difference between the system and battery is the V_{DS} of BATFET.

When the battery charging is disabled and above minimum system voltage setting or charging is terminated, the system is always regulated at typically 50mV above battery voltage. The status register VSYS_STAT bit goes high when the system is in minimum system voltage regulation.

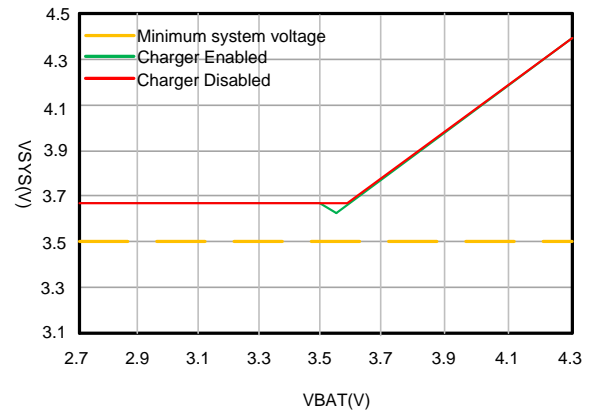

Figure5 System Voltage vs Battery Voltage

10.7.7.1 Dynamic Power Management

To meet maximum current limit in USB spec and avoid over loading the adapter, the device features Dynamic Power management (DPM), which continuously monitors the input current and input voltage. When input source is over-loaded, either the current exceeds the input current limit (IIDPM) or the voltage falls below the input voltage limit (VINDPM). The device then reduces the charge current until the input current falls below the input current limit and the input voltage rises above the input voltage limit.

When the charge current is reduced to zero, but the input source is still overloaded, the system voltage starts to drop. Once the system voltage falls below the battery voltage, the device automatically enters the supplement mode where the BATFET turns on and battery starts discharging so that the system is supported from both the input source and battery.

During DPM mode, the status register bits VINDPM_STAT (VINDPM) or IINDPM_STAT (IINDPM) goes high. Below figure shows the DPM response with 9-V/1.2-A adapter, 3.2-V battery, 2.8-A charge current and 3.5-V minimum system voltage setting.

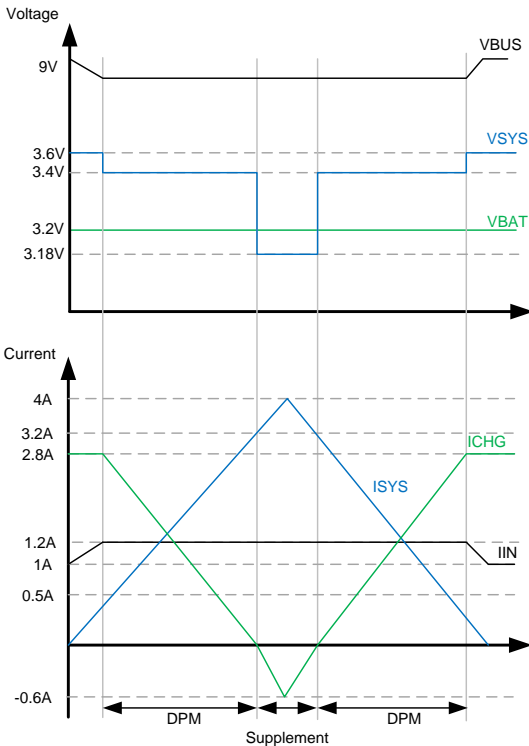

Figure6 DPM Response

10.7.7.2 Supplement Mode

When the system voltage falls below the battery voltage, the BATFET turns on and the BATFET gate is regulated the gate drive of BATFET so that the minimum BATFET V_{DS} stays at 30 mV when the current is low. This prevents oscillation from entering and exiting the supplement mode.

As the discharge current increases, the BATFET gate is regulated with a higher voltage to reduce $R_{DS(on)}$ until the BATFET is in full conduction. At this point onwards, the BATFET V_{DS} linearly increases with discharge current. BATFET turns off to exit supplement mode when the battery is below battery depletion threshold.

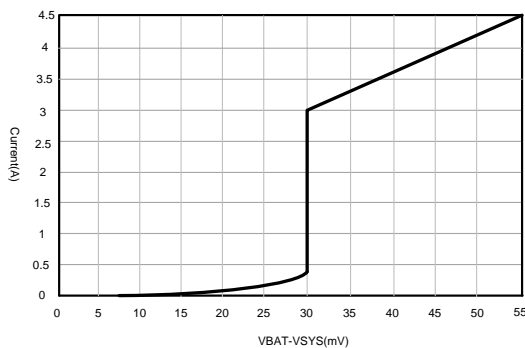

Figure7 BATFET V-I Curve

10.8 Shipping Mode and /QON Pin

10.8.1 BATFET Disable Mode(Shipping Mode)

To extend battery life and minimize power when system is powered off during system idle, shipping, or storage, the device can turn off BATFET so that the system voltage is zero to minimize the battery leakage current. When the host set BATFET_DIS bit, the charger can turn off BATFET immediately or delay by t_{BATFET_DLY} as configured by BATFET_DLY bit.

10.8.2 BATFET Enable(Exit Shipping Mode)

When the BATFET is disabled (in shipping mode) and indicated by setting BATFET_DIS, one of the following events can enable BATFET to restore system power:

1. Plug in adapter
2. Clear BATFET_DIS bit
3. Set REG_RST bit to reset all registers including BATFET_DIS bit to be default 0
4. A logic high to low transition on /QON pin with $t_{SHIPMODE}$ deglitch time to enable BATFET to exit shipping mode

10.8.3 BATFET Full System Reset

The BATFET functions as a load switch between battery and system when input source is not plugged-in. By changing the state of BATFET from on to off, systems connected to SYS can be effectively forced to have a power-on-reset. The /QON pin supports push-button interface to reset system power without host by changing the state of BATFET.

When the /QON pin is driven to logic low for t_{QON_RST} while input source is not plugged in and BATFET is enabled (BATFET_DIS = 0), the BATFET is turned off for t_{BATFET_RST} and then it is re-enabled to reset system power. This function can be disabled by setting BATFET_RST_EN bit to 0.

10.8.4 /QON Pin Operations

The /QON pin incorporates two functions to control BATFET.

1. BATFET Enable: A /QON logic transition from high to low with longer than $t_{SHIPMODE}$ deglitch turns on BATFET and exit shipping mode.
2. BATFET Reset: When /QON is driven to logic low by at least t_{QON_RST} while adapter is not plugged in (and BATFET_DIS = 0), the BATFET is turned off for t_{BATFET_RST} . The BATFET is re-enabled after t_{BATFET_RST} duration. This



function allows systems connected to SYS to have power-on-reset. This function can be disabled by setting BATFET_RST_EN bit to 0.

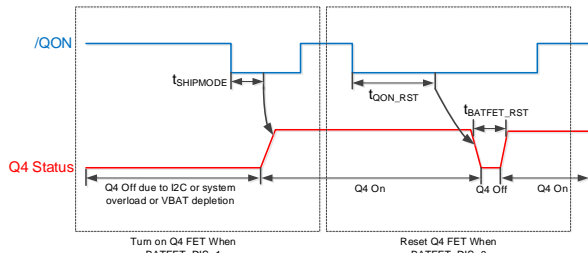

Figure8 SC89890H /QON Timing

10.9 Power Good Indicator

The PG_STAT bit goes HIGH to indicate a good input source when:

- VBUS above V_{VBUS_UVLO} below V_{VAC_OVP}
- VBUS above $V_{BAT} + V_{SLEEP}$ (not in sleep)
- VBUS above $V_{VBUSMIN}$ (typical 3.8 V) when I_{BADSRC} (typical 30 mA) current is applied (not a poor source)
- Completed input Source Type Detection

10.10 /INT

The SC89890H also has an alert mechanism that can output an interrupt signal via INT to notify the system of the operation by outputting a 256 μ s low-state INT pulse. All of the below events can trigger an INT output:

- USB/adaptor source identified
- Good input source detected as described in power good indicator
- Input Removed
- Charge Complete
- VINDPM/IINDPM event detected(can be masked)
- Watchdog timer out, Safety timer out, OTG fault(VBUS overload, VBUS OVP, $V_{BAT} < V_{VBATLOW_OTG}$), VBAT OVP, NTC COLD/HOT(Buck and Boost mode), Thermal shutdown, VBUS OVP, $V_{BUS} < V_{VBUSMIN}$

When a fault occurs, the charger device sends out INT and keeps the fault state in REG until the host reads the fault register. The INT signal can be masked when the corresponding control bit is set. When a fault/status change occurs, the charger device sends out an INT pulse and keeps the state in REG0C until the host reads the registers. To read the current status, the host has to read REG0C two times consecutively. The first read reports the pre-existing

register status and the second read reports the current register status.

10.11 Protections

10.11.1 Voltage and Current Monitoring in Buck Mode

10.11.1.1 Input Over voltage (ACOV)

If VBUS voltage exceeds V_{VAC_OVP} , the device stops switching immediately. During input over voltage event (ACOV), the fault register CHRG_FAULT bits are set to 01. An INT pulse is asserted to the host. The device will automatically resume normal operation once the input voltage drops back below the OVP threshold.

10.11.1.2 System Over voltage Protection(SYSOVP)

The charger device clamps the system voltage during load transient so that the components connect to system would not be damaged due to high voltage. SYSOVP threshold is 350 mV above minimum system regulation voltage when the system is regulate at V_{SYSMIN} and above battery regulation voltage when battery charging is terminated. Upon SYSOVP, converter stops switching immediately to clamp the overshoot. The charger provides 30 mA discharge current to bring down the system voltage.

10.11.2 Voltage and Current Monitoring in Boost Mode

10.11.2.1 VBUS Soft Start

When the boost function is enabled, the device soft-starts boost mode to avoid inrush current.

10.11.2.2 VBUS Over Load Protection

The device monitors boost output voltage and other conditions to provide output short circuit and over voltage protection. The Boost build in accurate constant current regulation to allow OTG to adaptive to various types of load. If short circuit is detected on VBUS, the Boost begins hiccup mode until the short is removed.

10.11.2.3 VBUS Over Voltage Protection

When the VBUS voltage rises above regulation target and exceeds V_{OTG_OVP} , the device enters over voltage protection which stops switching, clears OTG_CONFIG bit and exits boost mode. At Boost over voltage duration, the fault register bit (BOOST_FAULT) is set high to indicate fault in boost operation. An INT is also asserted to the host.

10.11.3 Thermal Regulation and Thermal Shutdown

10.11.3.1 Thermal Protection in Buck Mode

The SC89890H monitors the internal junction temperature T_J to avoid overheat the chip and limits the IC surface temperature in buck mode. When the internal junction temperature exceeds thermal regulation limit, the device lowers down the charge current. During thermal regulation, the actual charging current is usually below the programmed battery charging current. Therefore, termination is disabled, the safety timer runs at half the clock rate, and the status register THERM_STAT bit goes high.

Additionally, the device has thermal shutdown to turn off the converter and BATFET when IC surface temperature exceeds T_{SD} . The fault register CHRG_FAULT is set to 1 and an INT is asserted to the host. The BATFET and converter is enabled to recover when IC temperature is T_{SD_HYS} below T_{SD} .

10.11.3.2 Thermal Protection in Boost Mode

The device monitors the internal junction temperature to provide thermal shutdown during boost mode. When IC junction temperature exceeds T_{SD} , the boost mode is disabled by setting OTG_CONFIG bit low. When IC junction temperature is below $T_{SD} - T_{SD_HYS}$ the BATFET is enabled automatically to allow system to restore and the host can re-enable OTG_CONFIG bit to recover.

10.11.4 Battery Protection

10.11.4.1 Battery Over voltage Protection(VBATOVP)

The battery overvoltage limit is clamped at 4% above the battery regulation voltage. When battery over voltage occurs, the charger device immediately disables charging. The fault register BAT_FAULT bit goes high and an INT is asserted to the host.

10.11.4.2 Battery Over discharge Protection

When battery is discharged below V_{BAT_DPL} , the BATFET is turned off to protect battery from over discharge. To recover from over-discharge latch-off, an input source plug-in is required at VBUS. The battery is charged with I_{BAT_SHORT} (typically 50mA) current when the $V_{BAT} < V_{BAT_SHORT}$.

10.11.4.3 System Over current Protection

When the system is shorted or significantly overloaded ($I_{BAT} > I_{BAT_OCP}$ and $I_{BAT_OCP_DGL}$ deglitch) so that the current

exceeds BATFET over current limit, the BATFET latches off. Section BATFET Enable (Exit Shipping Mode) can reset the latch-off condition and turn on BATFET.

10.12 I2C Interface

10.12.1 I2C Interface

The IC features I2C interface, so the MCU or controller can control the IC flexibly. The 7-bit I2C address of the chip is 0x6A. The SDA and SCL pins are open drain and must be connected to the positive supply voltage via a current source or pull-up resistor. When the bus is free, both lines are HIGH. The I2C interface supports both standard mode (up to 100kbits) and fast mode (up to 400k bits with 5 k Ω pull up resistor at SCL pin and SDA pin respectively).

10.12.2 Data Validity

The data on the SDA line must be stable during the HIGH period of the clock. The HIGH or LOW state of the data line can only change when the clock signal on the SCL line is LOW. One clock pulse is generated for each data bit transferred.

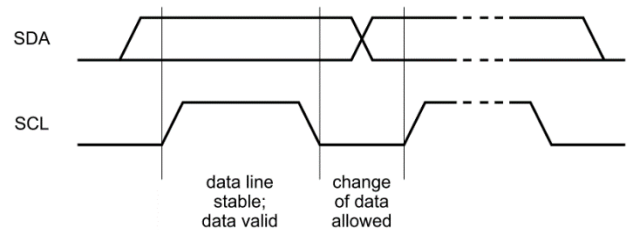

Figure 9 Bit transfer on the I2C bus

10.12.3 START and STOP Conditions

All transactions begin with a START (S) and are terminated by a STOP (P). A HIGH to LOW transition on the SDA line while SCL is HIGH defines a START condition. A LOW to HIGH transition on the SDA line while SCL is HIGH defines a STOP condition.

START and STOP conditions are always generated by the master. The bus is considered to be busy after the START condition. The bus is considered to be free again a certain time after the STOP condition.

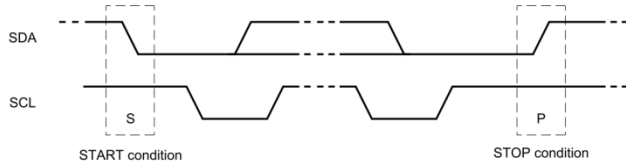

Figure 10 START and STOP conditions

10.12.4 Byte Format

Every byte put on the SDA line must be eight bits long. The number of bytes that can be transmitted per transfer is unrestricted. Each byte must be followed by an Acknowledge bit. Data is transferred with the Most Significant Bit (MSB) first. If a slave cannot receive or transmit another complete byte of data until it has performed some other function, for example servicing an internal interrupt, it can hold the clock line SCL LOW to force the master into a wait state. Data transfer then continues when the slave is ready for another byte of data and releases clock line SCL.

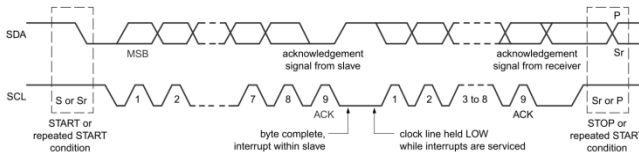

Figure 11 Data transfer on the I2C bus

10.12.5 Acknowledge (ACK) and Not Acknowledge (NACK)

The acknowledge takes place after every byte. The acknowledge bit allows the receiver to signal the transmitter that the byte was successfully received and another byte may be sent. During data is transferred, the master can either be the transmitter or the receiver. No matter what it is, the master generates all clock pulses, including the acknowledge ninth clock pulse.

The transmitter releases the SDA line during the acknowledge clock pulse so the receiver can pull the SDA line LOW and it remains stable LOW during the HIGH period of this clock pulse.

When SDA remains HIGH during this ninth clock pulse, this is defined as the Not Acknowledge signal. The master can then generate either a STOP condition to abort the transfer, or a repeated START condition to start a new transfer.

10.12.6 The slave address and R/W bit

Data transfers follow the format shown in below. After the START condition (S), a slave address is sent. This address is seven bits long followed by an eighth bit which is a data

direction bit (R/W) — a 'zero' indicates a transmission (WRITE), a 'one' indicates a request for data (READ). A data transfer is always terminated by a STOP condition (P) generated by the master. However, if a master still wishes to communicate on the bus, it can generate a repeated START condition (Sr) and address another slave without first generating a STOP condition.

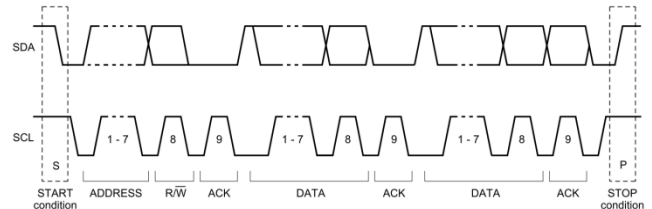

Figure 12 complete data transfer



Figure 13 The first byte after the START procedure

10.12.7 Single Read and Write

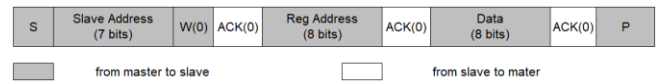

Figure 14 Single Write

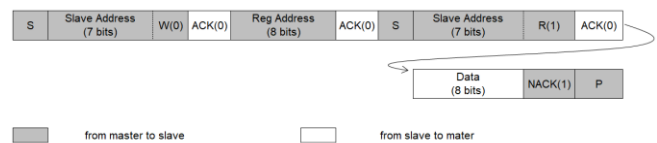

Figure 15 Single Read

If the register address is not defined, the charger IC send back NACK and go back to the idle state.

10.12.8 Multi-Read and Multi-Write

The IC supports multi-read and multi-write for continuous registers.

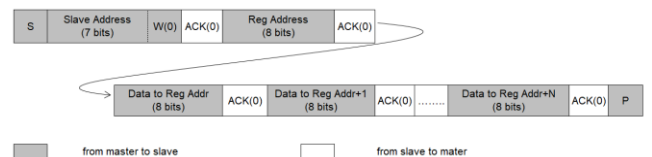

Figure 16 Multi-Write

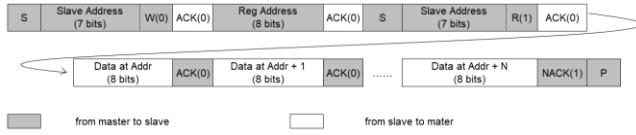

Figure 17 Multi-Read



11 Register Map

Addr	Register	Type	Default value @POR	Bit 7	Bit 6	Bit 5	Bit 4	Bit 3	Bit 2	Bit 1	Bit 0
00H	INPUT CONTROL	R/W	01001000	EN_HIZ	EN_LIM	I _{IN_DPM}					
01H	DPDM CONTROL1	R/W	000000X1	DP_DAC			DM_DAC			RESERVED	VINDPM_OS
02H	DPDM CONTROL2	R/W	00011X01	CONV_START	CONV_RATE	BOOST_FREQ	ICO_EN	HVDCP_EN	RESERVED	FORCE_DPDM	AUTO_DPDM_EN
03H	SYSTEM CONTROL1	R/W	00011010	FORCE_DSEL	WD_RST	OTG_CONFIG	CHG_CONFIG	V _{sys_min}			V _{VBATLOW_OTG}
04H	ICC	R/W	00100010	EN_PUMPX	I _{cc}						
05H	ITC & ITERM	R/W	00010100	I _{tc}				I _{term}			
06H	VBAT_REG	R/W	01011110	V _{BAT_REG}						V _{TC}	V _{RECHG}
07H	SYSTEM CONTROL2	R/W	10011101	EN_TERM	STAT_DIS	T _{WD}		EN_TIMER	T _{CHG}		JEITA_ISET
08H	TREG	R/W	00000011	BAT_COMP			VCLAMP			TREG	
09H	SYSTEM CONTROL3	R/W	01000100	FORCE_ICCO	TMR2X_EN	BATFET_DIS	JEITA_VSET_WARM	BATFET_DLY	BATFET_RST_EN	PUMPX_UP	PUMPX_DN
0AH	BOOST CONTROL	R/W	10110011	V _{BOOST}				PFM_OTG_DIS	I _{BOOST}		
0BH	STAT1	R	XXXXXXXX	VBUS_STAT			CHRG_STAT		PG_STAT	RESERVED	VSYS_STAT
0CH	STAT2	R	XXXXXXXX	WATCHDOG_FAULT	OTG_FAULT	CHRG_FAULT		BAT_FAULT	NTC_FAULT		
0DH	VINDPM	R/W	00010010	FORCE_VINDPM	VINDPM						
0EH	STAT3	R	XXXXXXXX	THERMAL_STAT	ADC_VBAT						
0FH	STAT4	R	XXXXXXXX	RESERVED	ADC_VSYS						
10H	STAT5	R	XXXXXXXX	RESERVED	RESERVED						
11H	STAT6	R	XXXXXXXX	VBUS_GD	ADC_VBUS						
12H	STAT7	R	XXXXXXXX	RESERVED	ADC_ICC						
13H	STAT8	R	XXXXXXXX	VINDPM_STAT	IINDPM_STAT	IDPM_ICO					
14H	PN	R	0X100XXX	REG_RST	ICO_STAT	PART NUMBER			RESERVED	RESERVED	RESERVED

REG 00H([Back to map](#))

Bit	Mode	Bit Name	Default value @POR	Reset by REG_RST	Reset by WTD	Description	Notes
7	R/W	EN_HIZ	0	Y	Y	Enable HI-Z Mode 0: Disable 1: Enable	Reset to default value when input source is plugged-in
6	R/W	EN_LIM	1	Y	Y	Enable ILIM Pin 0: Disable 1: Enable	
5	R/W	I _{INDPM}	0	Y	N	1600mA	Input current limit
4	R/W		0	Y	N	800mA	Offset: 100 mA
3	R/W		1	Y	N	400mA	Range: 100 mA – 3.25A
2	R/W		0	Y	N	200mA	Default:500 mA
1	R/W		0	Y	N	100mA	,maximum input current limit, not typical.
0	R/W		0	Y	N	50mA	IINDPM bits are changed automatically after input source detection is completed Host can over-write IINDPM register bits after input source detection is completed.

REG 01H([Back to map](#))

Bit	Mode	Bit Name	Default value @POR	Reset by REG_RST	Reset by WTD	Description	Notes
7	R/W	DP_DAC	0	Y	N	000: HI-Z	
6	R/W		0	Y	N	001: 20K PULL DOWN	
5	R/W		0	Y	N	010: 0.6V 011: 1.2V 100: 2V 101: 2.7V 110: 3.3V 111: RESERVED	
4	R/W	DM_DAC	0	Y	N	000: HI-Z	
3	R/W		0	Y	N	001: 20K PULL DOWN	
2	R/W		0	Y	N	010: 0.6V 011: 1.2V 100: 2V 101: 2.7V 110: 3.3V 111: RESERVED	
1	R/W	RESERVED		Y	N		
0	R/W	VINDPM_OS	1	Y	N	VINDPM Offset 0: 400mV 1: 600mV	

REG 02H([Back to map](#))

Bit	Mode	Bit Name	Default value @POR	Reset by REG_RST	Reset by WTD	Description	Notes
7	R/W	CONV_START	0	Y	Y	ADC Conversion Start Control 0: ADC conversion not active 1: Start ADC Conversion	This bit is read-only when CONV_RATE = 1. The bit stays high during ADC conversion and during input source detection.
6	R/W	CONV_RATE	0	Y	Y	ADC Conversion Rate Selection 0: One shot ADC conversion 1: Start 1s Continuous Conversion	
5	R/W	BOOST_FREQ	0	Y	Y	Boost Mode Frequency Selection 0: 1.5MHz 1: 500KHz	
4	R/W	ICO_EN	1	Y	N	Input Current Optimizer (ICO) Enable 0: Disable ICO Algorithm 1: Enable ICO Algorithm	
3	R/W	HVDCP_EN	1	Y	N	High Voltage DCP handshake when DCP is identified 0: Disable HVDCP handshake 1: Enable HVDCP handshake	
2	R/W	RESERVED					
1	RW1C	FORCE_DPDM	0	Y	Y	Force DP/DM Detection 0: Not in DP/DM detection 1: Force DP/DM detection	
0	R/W	AUTO_DPDPM_EN	1	Y	N	0: Disable DP/DM detection when VBUS is plugged-in 1: Enable DP/DM detection when VBUS is plugged-in	

REG 03H([Back to map](#))

Bit	Mode	Bit Name	Default value @POR	Reset by REG_RST	Reset by WTD	Description	Notes
7	R/W	FORCE_DSEL	0	Y	N	0: Allow DSEL pin output to drive low 1: Force DSEL pin output to drive high	
6	RW1C	WD_RST	0	Y	Y	I2C Watchdog Timer Reset 0: Normal 1: Reset	
5	R/W	OTG_CONFIG	0	Y	Y	Boost Mode Configuration 0: OTG Disable 1: OTG Enable	
4	R/W	CHG_CONFIG	1	Y	Y	Charge Enable Configuration 0: Charge Disable 1: Charge Enable	
3	R/W	V _{sys_min}	1	Y	N	000:2.6V	
2	R/W		0	Y	N	001:2.8V	
1	R/W		1	Y	N	010:3V 011:3.2V 100:3.4V 101:3.5V 110:3.6V 111:3.7V	
0	R/W	V _{BATLOW_OTG}	0	Y	Y	Minimum Battery Voltage (falling) to exit boost mode 0: 2.8V 1: 2.5V	

REG 04H([Back to map](#))

Bit	Mode	Bit Name	Default value @POR	Reset by REG_RST	Reset by WTD	Description	Notes
7	R/W	EN_PUMPX	0	Y	Y	0: Disable Current pulse control 1: Enable Current pulse control (PUMPX_UP and PUMPX_DN)	
6	R/W	I _{CC}	0	Y	Y	3840 mA	Fast Charge Current Offset: 0mA Range: 0mA – 5040mA
5	R/W		1	Y	Y	1920 mA	
4	R/W		0	Y	Y	960 mA	
3	R/W		0	Y	Y	480 mA	
2	R/W		0	Y	Y	240 mA	
1	R/W		1	Y	Y	120 mA	
0	R/W		0	Y	Y	60 mA	

REG 05H([Back to map](#))

Bit	Mode	Bit Name	Default value @POR	Reset by REG_RST	Reset by WTD	Description	Notes
7	R/W	I _{TC}	0	Y	Y	480 mA	Trickle Current Offset: 60mA Range: 60mA – 960mA
6	R/W		0	Y	Y	240 mA	
5	R/W		0	Y	Y	120 mA	
4	R/W		1	Y	Y	60 mA	
3	R/W	I _{TERM}	0	Y	Y	480 mA	Termination Current Offset: 30mA Range: 30mA – 930mA
2	R/W		1	Y	Y	240 mA	
1	R/W		0	Y	Y	120 mA	
0	R/W		0	Y	Y	60 mA	

REG 06H([Back to map](#))

Bit	Mode	Bit Name	Default value @POR	Reset by REG_RST	Reset by WTD	Description	Notes
7	R/W	V _{BAT_REG}	0	Y	Y	512 mV	Charge Voltage Offset: 3.840V Range: 3.84V-4.848V
6	R/W		1	Y	Y	256 mV	
5	R/W		0	Y	Y	128 mV	
4	R/W		1	Y	Y	64 mV	
3	R/W		1	Y	Y	32 mV	
2	R/W		1	Y	Y	16 mV	
1	R/W	V _{TC}	1	Y	Y	Battery TC to CC Charge Threshold 0: 2.8V 1: 3.0V	
0	R/W	V _{RECHG}	0	Y	Y	Battery Recharge Threshold (below Charge Voltage) 0: 100mV 1: 200mV	

REG 07H([Back to map](#))

Bit	Mode	Bit Name	Default value @POR	Reset by REG_RST	Reset by WTD	Description	Notes
7	R/W	EN_TERM	1	Y	Y	Charging Termination Enable 0: Disable 1: Enable	
6	R/W	STAT_DIS	0	Y	Y	0: Enable STAT pin function 1: Disable STAT pin function	
5	R/W	T _{WD}	0	Y	Y	I2C Watchdog Timer Setting	
4	R/W		1	Y	Y	00: Disable watchdog timer 01: 40s 10: 80s 11: 160s	
3	R/W	EN_TIMER	1	Y	Y	Charging Safety Timer Enable 0: Disable 1: Enable	
2	R/W	T _{CHG}	1	Y	Y	Fast Charge Timer Setting	
1	R/W		0	Y	Y	00: 5 hrs 01: 8 hrs 10: 12 hrs 11: 20 hrs	
0	R/W	JEITA_ISET	1	Y	Y	JEITA Cool Temperature Current Setting 0: 50% of ICC 1: 20% of ICC	

REG 08H([Back to map](#))

Bit	Mode	Bit Name	Default value @POR	Reset by REG_RST	Reset by WTD	Description	Notes
7	R/W	BAT_COMP	0	Y	Y	80 mΩ	IR Compensation Resistor Setting Range: 0-140mΩ Default: 0mΩ
6	R/W		0	Y	Y	40 mΩ	
5	R/W		0	Y	Y	20 mΩ	
4	R/W	VCLAMP	0	Y	Y	128 mV	IR Compensation Resistor Setting Range: 0-224mV Default: 0mV
3	R/W		0	Y	Y	64 mV	
2	R/W		0	Y	Y	32 mV	
1	R/W	T _{REG}	1	Y	Y	Thermal Regulation	
0	R/W		1	Y	Y	00: 60°C 01: 80°C 10: 100°C 11: 120°C	

Reg 09H([Back to map](#))

Bit	Mode	Bit Name	Default value @POR	Reset by REG_RST	Reset by WTD	Description	Notes
7	RW1C	FORCE_ICO	0	Y	Y	0: Do not force ICO 1: Force ICO	
6	R/W	TMR2X_EN	1	Y	Y	Safety Timer Setting during DPM or Thermal Regulation 0: Safety timer not slowed by 2X during input DPM or thermal regulation or JEITA 1: Safety timer slowed by 2X during input DPM or thermal regulation or JEITA	
5	R/W	BATFET_DIS	0	Y	N	0: Allow BATFET turn on 1: Turn off BATFET	
4	R/W	JEITA_VSET_WARM	0	Y	Y	JEITA Warm Temperature Voltage Setting 0: Set Charge Voltage to VREG-200mV during JEITA warm temperature 1: Set Charge Voltage to VREG during JEITA high temperature	
3	R/W	BATFET_DLY	0	Y	N	0: Turn off BATFET immediately when BATFET_DIS bit is set 1: Turn off BATFET after t_{BATFET_DLY} (typ. 10 s) when BATFET_DIS bit is set	
2	R/W	BATFET_RST_EN	1	Y	N	0: Disable BATFET reset function 1: Enable BATFET reset function	
1	RW1C	PUMPX_UP	0	Y	Y	Current pulse control voltage up enable 0: Disable 1: Enable	
0	RW1C	PUMX_DN	0	Y	Y	Current pulse control voltage down enable 0: Disable 1: Enable	

Reg 0AH([Back to map](#))

Bit	Mode	Bit Name	Default value @POR	Reset by REG_RST	Reset by WTD	Description	Notes	
7	R/W	V _{BOOST}	1	Y	Y	800 mV	Offset:3.9V Range:3.9V-5.4V	
6	R/W		0	Y	Y	400 mV		
5	R/W		1	Y	Y	200 mV		
4	R/W		1	Y	Y	100 mV		
3	R/W	PFM_OTG_DIS	0	Y	N	PFM mode allowed in boost mode 0: Allow PFM in boost mode 1: Disable PFM in boost mode		
2	R/W	I _{BOOST}	0	Y	N	000: 0.5A		
1	R/W		1	Y	N	001: 0.75A		
0	R/W		010: 1.2A	1	Y	N		011: 1.4A
			100: 1.65A					101: 1.875A

Reg 0BH([Back to map](#))

Bit	Mode	Bit Name	Default value @POR	Reset by REG_RST	Reset by WTD	Description	Notes
7	R	VBUS_STAT	X	NA	NA	VBUS Status register	
6	R		X	NA	NA	000: No Input	
5	R		X	NA	NA	001: USB Host SDP 010: USB CDP (1.5A) 011: USB DCP (3.25A) 100: HVDCP 101: Unknown Adapter (500mA) 110: Non-Standard Adapter (1A/2A/2.1A/2.4A) 111: OTG Note: Software current limit is reported in IINLIM register	
4	R	CHRG_STAT	X	NA	NA	Charging status:	
3	R		X	NA	NA	00: Not Charging 01:TC Charging 10:CC Charging 11: Charge Termination	
2	R	PG_STAT	X	NA	NA	Power Good status: 0: Power Not Good 1:Power Good	
1	R	RESERVED					
0	R	VSYS_STAT	X	NA	NA	0:Not in V_{SYS_MIN} regulation (BAT > V_{SYS_MIN}) 1:in V_{SYS_MIN} regulation (BAT < V_{SYS_MIN})	

Reg 0CH([Back to map](#))

Bit	Mode	Bit Name	Default value @POR	Reset by REG_RST	Reset by WTD	Description	Notes
7	R	WATCHDOG_FAULT	X	NA	NA	0: Normal 1: Watchdog timer expiration	
6	R	BOOST_FAULT	X	NA	NA	0: Normal 1: VBUS overloaded in OTG, or VBUS OVP, or battery is too low (any conditions that we cannot start boost function)	
5	R	CHRG_FAULT	X	NA	NA	00: Normal;	
4	R		X	NA	NA	01: input fault (VAC OVP or VBAT < VBUS < 3.8 V); 10: Thermal shutdown; 11: Charge Safety Timer Expiration	
3	R	BAT_FAULT	X	NA	NA	0: Normal 1: BATOVP	
2	R	NTC_FAULT	X	NA	NA	NTC Fault Status	
1	R		X	NA	NA	Buck Mode:	
0	R		X	NA	NA	000: Normal 010: NTC Warm 011: NTC Cool 101: NTC Cold 110: NTC Hot Boost Mode: 000: Normal 101: NTC Cold 110: NTC Hot	

Reg 0DH([Back to map](#))

Bit	Mode	Bit Name	Default value @POR	Reset by REG_RST	Reset by WTD	Description	Notes
7	R/W	FORCE_VINDPM	0	Y	N	VINDPM Threshold Setting Method 0: Run Relative VINDPM Threshold 1: Run Absolute VINDPM Threshold	Reset to default value when input source is plugged-in
6	R/W	VINDPM	0	Y	N	6400 mV	Absolute VINDPM Threshold Offset: 2.6V Effective Range: 3.9V-15.3V Reset to default value when input source is plugged-in
5	R/W		0	Y	N	3200 mV	
4	R/W		1	Y	N	1600 mV	
3	R/W		0	Y	N	800 mV	
2	R/W		0	Y	N	400 mV	
1	R/W		1	Y	N	200 mV	
0	R/W		0	Y	N	100 mV	

Reg 0EH([Back to map](#))

Bit	Mode	Bit Name	Default value @POR	Reset by REG_RST	Reset by WTD	Description	Notes
7	R	THERMAL_STAT	X	NA	NA	Thermal Regulation Status 0: Normal 1: In Thermal Regulation	
6	R	ADC_VBAT	X	NA	NA	1280 mV	Offset: 2.304V Range: 2.304V (0000000) – 4.848V (1111111)
5	R		X	NA	NA	640 mV	
4	R		X	NA	NA	320 mV	
3	R		X	NA	NA	160 mV	
2	R		X	NA	NA	80 mV	
1	R		X	NA	NA	40 mV	
0	R		X	NA	NA	20 mV	

**Reg 0FH**([Back to map](#))

Bit	Mode	Bit Name	Default value @POR	Reset by REG_RST	Reset by WTD	Description	Notes
7	R	RESERVED	X	NA	NA		
6	R	ADC_VSYS	X	NA	NA	1280 mV	Offset: 2.304V Range: 2.304V (0000000) – 4.848V (1111111)
5	R		X	NA	NA	640 mV	
4	R		X	NA	NA	320 mV	
3	R		X	NA	NA	160 mV	
2	R		X	NA	NA	80 mV	
1	R		X	NA	NA	40 mV	
0	R		X	NA	NA	20 mV	

Reg 10H([Back to map](#))

Bit	Mode	Bit Name	Default value @POR	Reset by REG_RST	Reset by WTD	Description	Notes
7	R	RESERVED	X	NA	NA		
6	R	RESERVED	X	NA	NA		
5	R	RESERVED	X	NA	NA		
4	R	RESERVED	X	NA	NA		
3	R	RESERVED	X	NA	NA		
2	R	RESERVED	X	NA	NA		
1	R	RESERVED	X	NA	NA		
0	R	RESERVED	X	NA	NA		

Reg 11H([Back to map](#))

Bit	Mode	Bit Name	Default value @POR	Reset by REG_RST	Reset by WTD	Description	Notes
7	R	VBUS_GD	X	NA	NA	VBUS Good Status 0: Not VBUS attached 1: VBUS Attached	
6	R	ADC_VBUS	X	NA	NA	6400 mV	ADC VBUS Offset: 2.6V Range 2.6V (0000000) – 15.3V (1111111)
5	R		X	NA	NA	3200 mV	
4	R		X	NA	NA	1600 mV	
3	R		X	NA	NA	800 mV	
2	R		X	NA	NA	400 mV	
1	R		X	NA	NA	200 mV	
0	R		X	NA	NA	100 mV	

Reg 12H([Back to map](#))

Bit	Mode	Bit Name	Default value @POR	Reset by REG_RST	Reset by WTD	Description	Notes
7	R	RESERVED					
6	R	ADC_ICC	X	NA	NA	3200 mA	ADC conversion of Charge Current (IBAT) Offset: 0mA Range 0mA (0000000) – 6350mA (1111111)
5	R		X	NA	NA	1600 mA	
4	R		X	NA	NA	800 mA	
3	R		X	NA	NA	400 mA	
2	R		X	NA	NA	200 mA	
1	R		X	NA	NA	100 mA	
0	R		X	NA	NA	50 mA	

Reg 13H([Back to map](#))

Bit	Mode	Bit Name	Default value @POR	Reset by REG_RST	Reset by WTD	Description	Notes
7	R	VINDPM_STAT	X	NA	NA	VINDPM Status 0: Not in VINDPM 1: VINDPM	
6	R	IINDPM_STAT	X	NA	NA	IINDPM Status 0: Not in IINDPM 1: IINDPM	
5	R	IDPM_ICO	X	NA	NA	1600 mA	Input Current Limit in effect while Input Current Optimizer (ICO) is enabled Offset: 100mA (default) Range 100mA (0000000) – 3.25A (1111111)
4	R		X	NA	NA	800 mA	
3	R		X	NA	NA	400 mA	
2	R		X	NA	NA	200 mA	
1	R		X	NA	NA	100 mA	
0	R		X	NA	NA	50 mA	

Reg 14H([Back to map](#))

Bit	Mode	Bit Name	Default value @POR	Reset by REG_RST	Reset by WTD	Description	Notes
7	RW1C	REG_RST	0	NA	NA	Register Reset 0: Keep current register setting 1: Reset to default register value and reset safety timer	
6	R	ICO_STAT	X	NA	NA	Input Current Optimizer (ICO) Status 0: ICO is in progress 1: ICO Finished	
5	R	PN	1	NA	NA	Part Number	
4	R		0	NA	NA		
3	R		0	NA	NA		
2	R	RESERVED					
1	R	RESERVED					
0	R	RESERVED					



12 MECHANICAL DATA

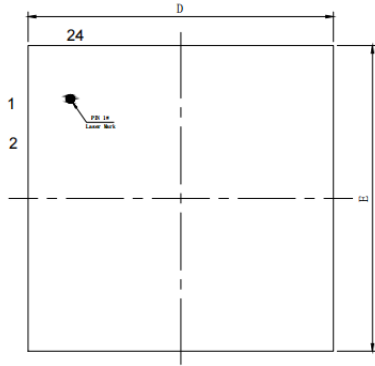

TOP VIEW

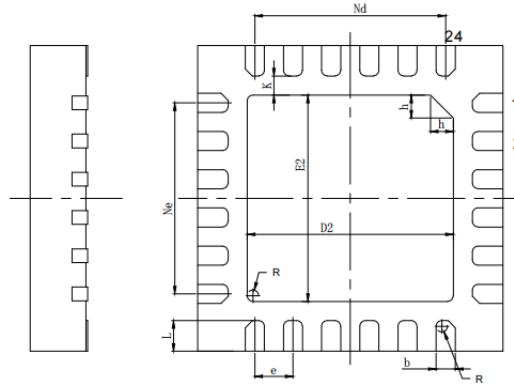

BOTTOM VIEW

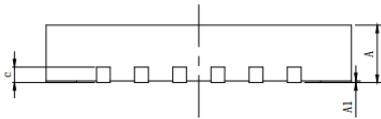

SIDE VIEW

SYMBOL	MILLIMETER		
	MIN	NOM	MAX
A	0.70	0.75	0.80
A1	0	0.02	0.05
b	0.20	0.25	0.30
c	0.203REF		
D	3.90	4.00	4.10
D2	2.60	2.70	2.80
e	0.50BSC		
Nd	2.50BSC		
Ne	2.50BSC		
E	3.90	4.00	4.10
E2	2.60	2.70	2.80
L	0.35	0.40	0.45
h	0.25	0.30	0.35
K	0.25REF		
R	0.075REF		



RECOMMENDED FOOTPRINT(Unit mm)

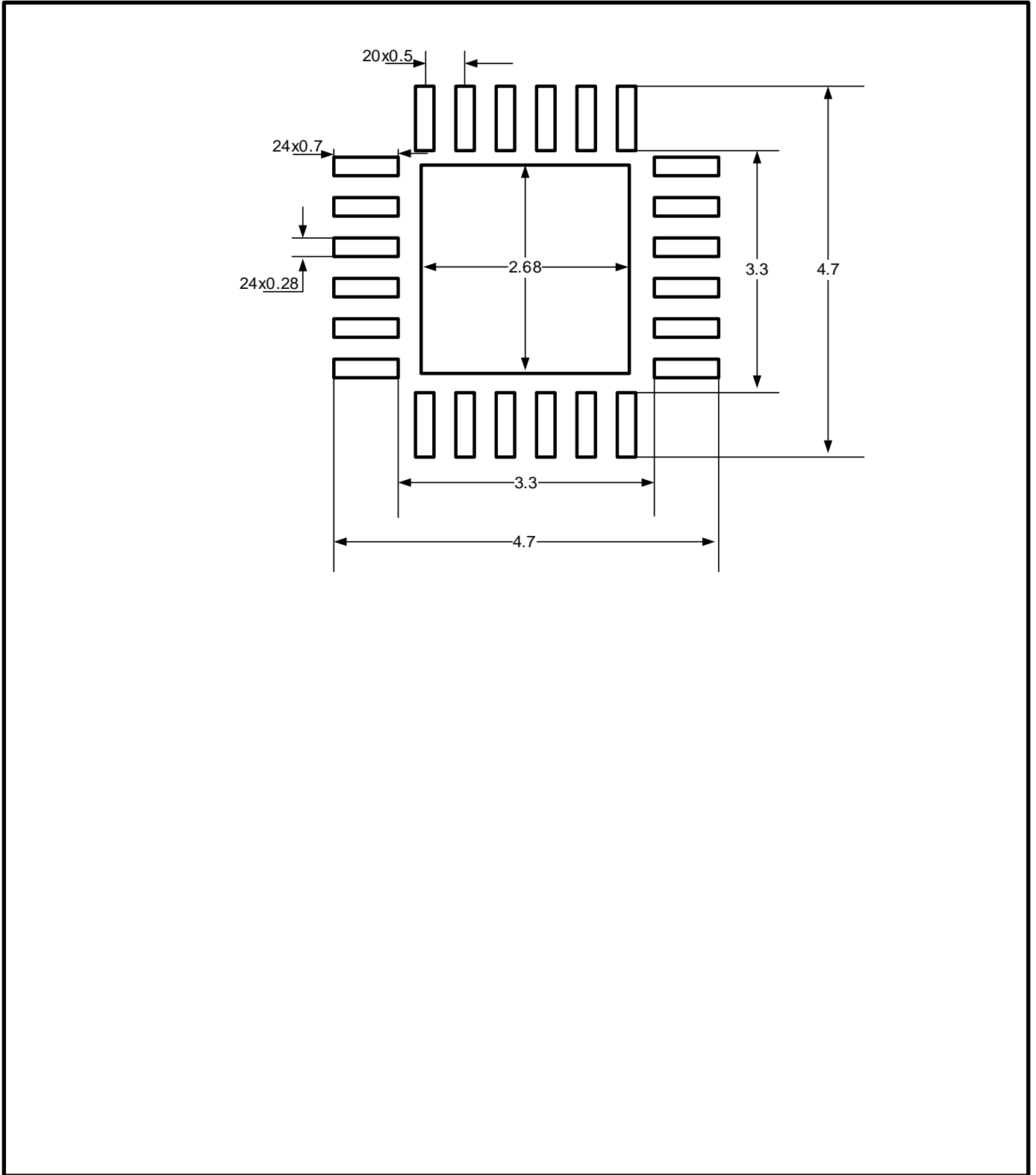



Important Notice and Disclaimer

Southchip Semiconductor Technology (Shanghai) Co., Ltd. and its subsidiaries (“**SOUTHCHIP**”) provides technical and reliability data (including datasheets), design resources (including reference designs, software), application or other design advice and other resources (“**Resources**”) “**AS IS**” AND WITH ALL FAULTS.

The Resources are intended for skilled developers designing with SOUTHCHIP’s products. SOUTHCHIP may provide but **DISCLAIMS WARRANTY FOR** SOUTHCHIP’s technical support or design services for the customers. Customers are solely responsible for (1) selecting and using the appropriate SOUTHCHIP’s products for your application, (2) designing, validating and testing your application, and (3) ensuring your application meets applicable standards, and any other safety, security, or other requirements. SOUTHCHIP **DISCLAIMS RESPONSIBILITY FOR** any claims, damages, costs, losses, liabilities arising out of Customers’ use of the Resources.

SOUTHCHIP’s sample products are provided “**AS IS**” and only for purposes of designing, validating and testing. SOUTHCHIP reserves the right to make changes, corrections, enhancements, modifications and improvements to SOUTHCHIP’s products and/or to the Resources at any time without notice. Customers shall, prior to, mass producing, using or distributing any products of their own that incorporate SOUTHCHIP’s products, obtain the latest relevant information on SOUTHCHIP’s products and thoroughly test such products for purposes of mass production, quality and safety. Use of SOUTHCHIP’s products without a safety design is fully at the risk of Customers, subject only to applicable laws and regulations governing limitations on product liability.